

PICTURE

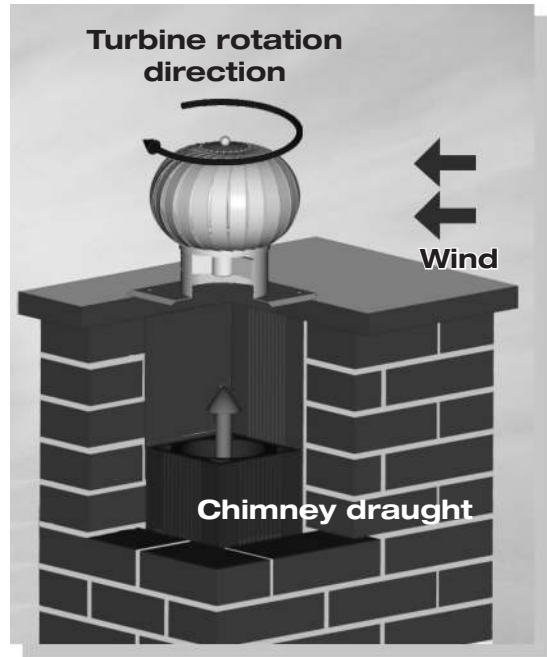

FUNCTION PRINCIPLE



DESCRIPTION

Rotary chimney cowl Turbowent is a device, which, in a dynamic way, uses force of the wind to increase chimney draught. The turbine always rotates in the same direction no matter of the wind strength or its direction. It is to be mounted on gravitation based ventilation chimney duct endings.

Maximal working temperature: 150 [°C]
Rotating unit: ball bearing system sunk in high-temperature oil

DESTINATION

- when there are wind fluctuations on the chimney duct ending, caused by its bad location
- when there is an unfavorable terrain configuration, with strong and frequent winds
- when there is a lack of chimney draught or it is too weak
- in order to improve the natural (gravitation) ventilation.

MEASUREMENTS

Diameter	Turbine diameter D
Ø150	~ 260
Ø200	~ 320
Ø250	~ 380
Ø300	~ 460

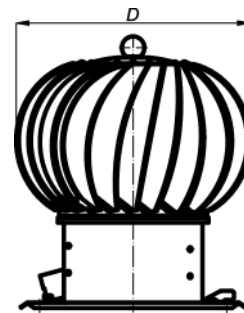

DENOTATIONS / PRODUCT CODES

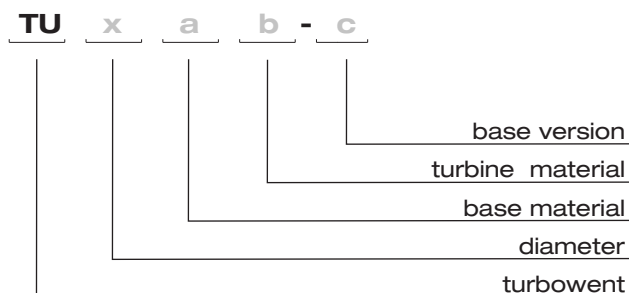

MATERIALS

Destination	W	W	W	W	W - ventilation ducts
	-	-	-	-	S - gas and oil exhaust ducts
	-	-	-	-	D - smoke ducts
Base material	CH	-	CH	-	CH - chrome - nickel sheet 1.4301
	-	OC	-	-	OC - galvanised steel sheet
	-	-	-	-	AL - aluminum
	-	-	-	ML	ML- powder coated
Turbine material	CH	-	-	-	CH - chrome - nickel sheet 1.4301
	-	AL	AL	-	AL - aluminum
	-	-	-	ML	ML- powder coated

TURBOWENT - VERSIONS OF BASES

1. SQUARE BASE OPENABLE
Ø150, Ø200, Ø250



STANDARD

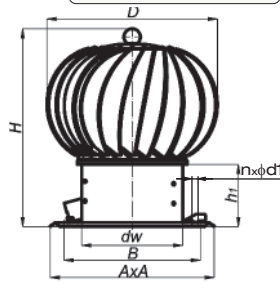

SQUARE BASE NOT OPENABLE Ø300



STANDARD

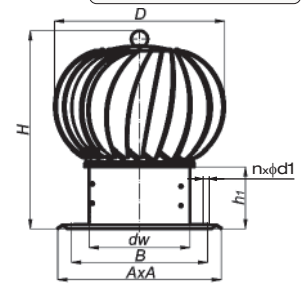

2. DISMOUNTABLE BASE



-R

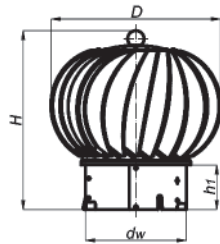

3. BASE WITH COLLAR



-BIII

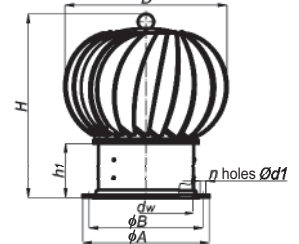

4. BASE WITH INSULATION CLOSING



-B-K

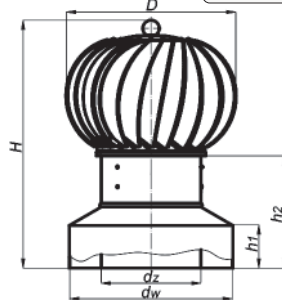

5. FORCE-IN MOUNTING BASE



-PT

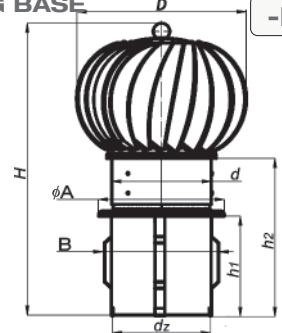

6. INLET PIPE OPENABLE
Ø150, Ø200, Ø250



-B

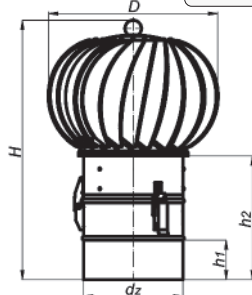

7. INLET PIPE NOT OPENABLE



-B-S

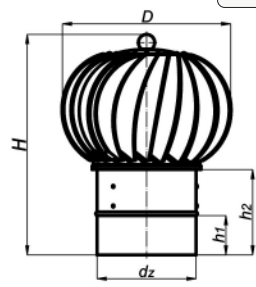

8. INLET PIPE REDUCED



-X/Y-...-B-S

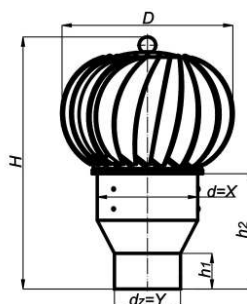

9. INLET PIPE REDUCED OPENABLE
Ø150, Ø200, Ø250, Ø300



-X/Y-...-B

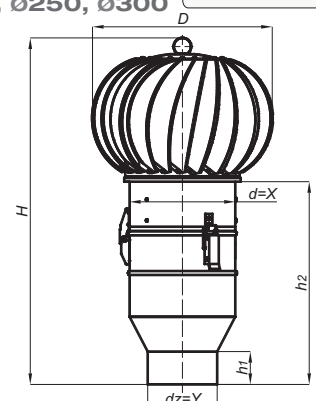

MEASUREMENTS TABLE FOR VARIOUS INLET DIAMETERS

ø 150		Dimensions [mm]									Weight [kg]			
Lp	Base version	d _w	d _z	H	h ₁	h ₂	A	B	d ₁	Amount n	OCAL	CHAL	ML	CHCH
1	STANDARD	150.4	-	305	100	-	250	208	6.2	4	1.50	1.60	1.60	1.80
2	-R	150.4	-	320	105	-	-	-	-	-	1.40	1.45	1.45	1.65
3	-BIII	150.1	-	292	90	-	212	182	9.5	6	1.80	1.85	1.85	2.05
4	-B-K	253.4	151.7	399	70	194	-	-	-	-	2.00	2.20	2.05	2.40
5	-PT	-	144.0	450	157	244	187	158	-	-	1.75	1.85	1.85	2.05
6	-B	-	151.8	402	60	197	-	-	-	-	1.50	1.60	1.60	1.80
7	-B-S	-	151.7	349	60	144	-	-	-	-	1.35	1.40	1.40	1.60
8	-X/Y-...-B-S	-	Y	399	60	194	-	-	-	-	1.50	1.55	1.55	1.75
9	-X/Y-...-B	-	Y	492	60	287	-	-	-	-	1.80	1.90	1.90	2.10

holes

ø 200		Dimensions [mm]									Weight [kg]			
Lp	Base version	d _w	d _z	H	h ₁	h ₂	A	B	d ₁	Amount n	OCAL	CHAL	ML	CHCH
1	STANDARD	200.0	-	340	100	-	330	284.0	6.2	4	1.90	2.00	2.00	2.30
2	-R	199.7	-	355	105	-	-	-	-	-	1.45	1.50	1.50	1.80
3	-BIII	199.4	-	362	90	-	263	233	9.5	6	2.00	2.00	2.00	2.30
4	-B-K	303.1	201.0	434	70	194	-	-	-	-	2.35	2.50	2.40	2.80
5	-PT	-	194.0	494	167	254	237	208	-	-	2.05	2.20	2.10	2.50
6	-B	-	201.0	471	60	197	-	-	-	-	1.80	1.90	1.90	2.20
7	-B-S	-	201.0	384	60	144	-	-	-	-	1.55	1.60	1.60	1.90
8	-X/Y-...-B-S	-	Y	434	60	194	-	-	-	-	1.75	1.80	1.80	2.10
9	-X/Y-...-B	-	Y	527	60	287	-	-	-	-	2.16	2.26	2.26	2.56

ø 250		Dimensions [mm]									Weight [kg]			
Lp	Base version	d _w	d _z	H	h ₁	h ₂	A	B	d ₁	Amount n	OCAL	CHAL	ML	CHCH
1	STANDARD	250.7	-	410	105	-	380	330	6.2	4	2.50	2.60	2.60	3.10
2	-R	250.7	-	400	105	-	-	-	-	-	1.95	2.00	2.05	2.50
3	-BIII	250.7	-	432	100	-	313	283	9.5	8	3.35	3.45	3.45	3.95
4	-B-K	352.4	252.3	480	70	194	-	-	-	-	2.95	3.20	3.05	3.70
5	-PT	-	244.0	550	177	260	287	259	-	-	2.75	2.80	2.85	3.40
6	-B	-	252.3	541	60	197	-	-	-	-	2.40	2.50	2.50	3.00
7	-B-S	-	252.3	430	60	144	-	-	-	-	2.10	2.20	2.20	2.70
8	-X/Y-...-B-S	-	Y	480	60	190	-	-	-	-	2.30	2.40	2.40	2.90
9	-X/Y-...-B	-	Y	593	60	303	-	-	-	-	2.85	2.95	2.95	3.45

MEASUREMENTS TABLE FOR VARIOUS INLET DIAMETERS

ø 300		Dimensions [mm]									Weight [kg]			
Lp	Base version	d _w	d _z	H	h ₁	h ₂	A	B	d ₁	Amount _n	OCAL	CHAL	ML	CHCH
1	STANDARD	298.0	-	425	90	-	430	380	6.2	4	3.00	3.25	3.25	4.00
2	-R	300.0	-	419	105	-	-	-	-	-	2.00	2.10	2.10	2.85
3	-BIII	300.0	-	508	100	-	363	337	9.5	8	2.95	3.05	3.05	3.80
4	-B-K	403.7	301.6	499	70	194	-	-	-	-	3.25	3.50	3.50	4.30
5	-PT	-	294.0	569	177	244	337	308	-	-	3.00	3.20	3.20	4.00
6	-B	-	301.6	635	60	197	-	-	-	-	2.60	2.70	2.70	3.45
7	-B-S	-	301.6	553	60	144	-	-	-	-	2.20	2.30	2.30	3.05
8	-X/Y-...-B-S	-	Y	499	60	174	-	-	-	-	2.50	2.60	2.60	3.35
9	-X/Y-...-B	-	Y	612	60	287	-	-	-	-	3.10	3.20	3.20	3.95

AIRFLOW CHARTS

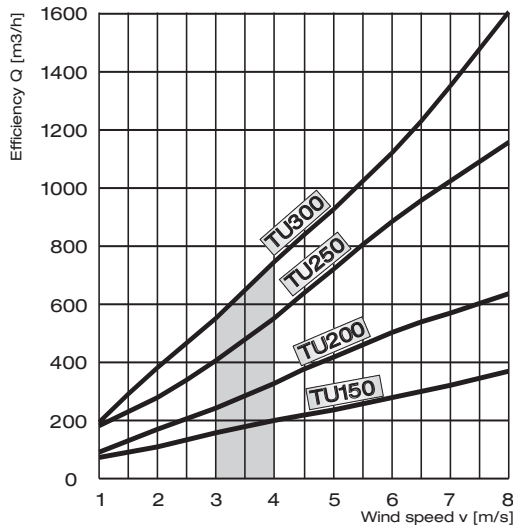

Efficiency chart for Turbowents (various diameters) in a function of wind speed, not including the influence of chimney height
*1 [m/s] = 3,6 [km/h]

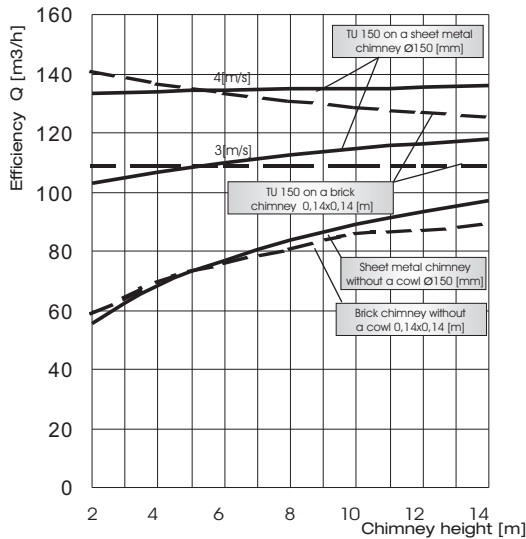

Efficiency chart for Turbowents Ø150 in a function of chimney height on a brick or sheet metal chimney (for two wind speeds: 3 and 4 [m/s])

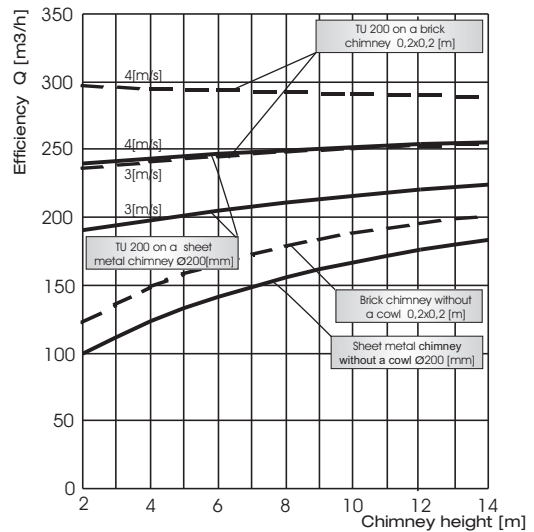

Efficiency chart for Turbowents Ø200 in a function of chimney height on a brick or sheet metal chimney (for two wind speeds: 3 and 4 [m/s])

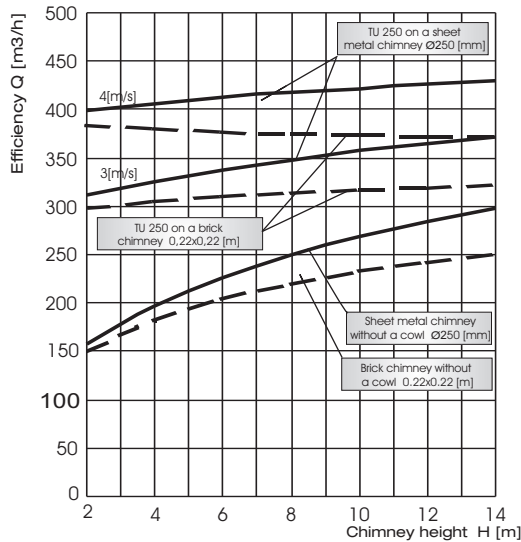

Efficiency chart for Turbowents Ø250 in a function of chimney height on a brick or sheet metal chimney (for two wind speeds: 3 and 4 [m/s])

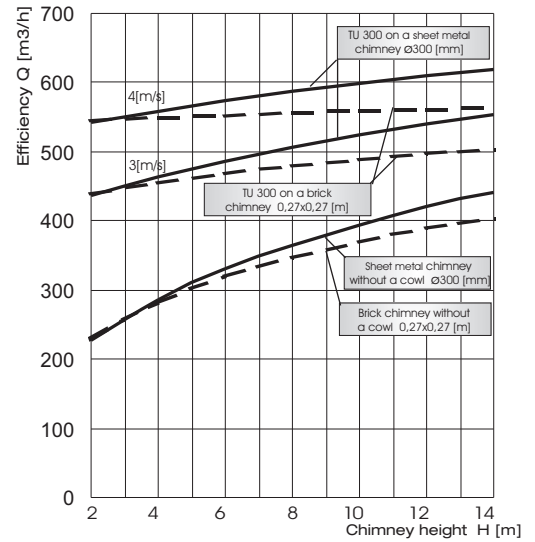

Efficiency chart for Turbowents Ø300 in a function of chimney height on a brick or sheet metal chimney (for two wind speeds: 3 and 4 [m/s])